

ANSWER SHEET

Welcome to Puzzled Pint!

Tonight your packet contains four puzzles. Each puzzle will somehow solve to a **short word or phrase**. If you're joining us for the first time tonight, please read our **Puzzling Basics** page by going to <http://www.puzzledpint.com/basics> or by scanning the QR code below. Note the "**How to solve**" section that discusses puzzle techniques like indexing and using the code sheet, which should have been provided to you along with your packet.

Puzzled Pint is **not a competitive event**. We encourage you to **ask Game Control (GC) for hints** as often as you'd like. Our goal is for you to have fun, not to be frustrated!

While we like to theme our puzzle sets, most puzzles do not require special knowledge of the theme to solve them. Still, using the internet is completely allowed and even expected for some puzzles.

When you've solved all four puzzles, confirm your answers with GC, and you'll get the final **meta-puzzle**, which requires the previous puzzle answers to solve.

When you're all finished, please **return this answer sheet to Game Control**, along with your code sheet and any borrowed items like pencils, tape, or scissors. Returning your answer sheet with an accurate count of your team size will allow us to make sure that we have enough space for everyone at our venues in future months and that we have enough puzzle packets available. Additionally, you'll be able to see how your time ranks relative to other teams worldwide on our web site.

If you'd like to provide any feedback on your experience tonight, please scan the QR code below or visit <http://www.puzzledpint.com/feedback>.

Thanks, and we sincerely hope you enjoy your evening! – *Puzzled Pint GC*

Team Name _____

Start Time _____ TEAM SIZE

End Time _____

Puzzle	Answer
--------	--------

Lab Rats ○ _ ○ _ ○ ○ _ ○ ○ ○ ○

Rat Genetics ○ _ ○ ○ ○ _ ○ _ ○ _ ○

Missing Rats _ ○ ○ ○ _ _ ○ ○ _ _ ○

Rat King ○ _ _ ○ ○ ○ _ _ ○ ○ ○
↓ ↓ ↓ ↓ ↓ ↓ ↓ ↓ ↓ ↓ ↓

Sewer Rats _ _ _ _ _ _ _ _ _ _



Puzzling Basics



Feedback

LAB RATS

Each rat had run its own maze so many times, it knew the decisions by heart. When they ran each other's mazes, they learned what had been done to them.

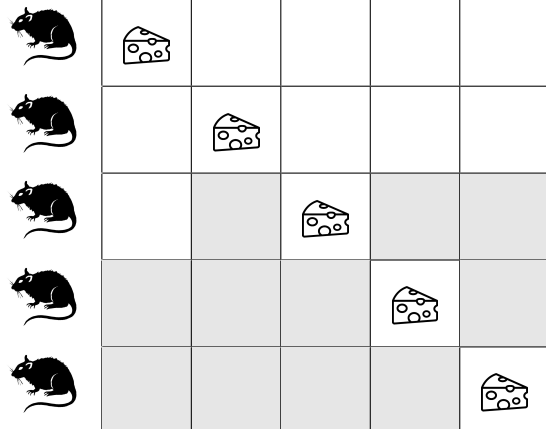
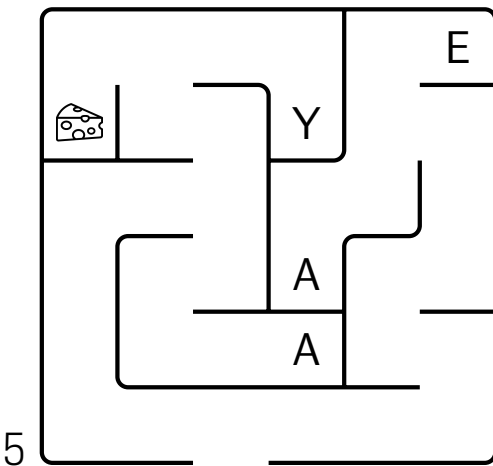
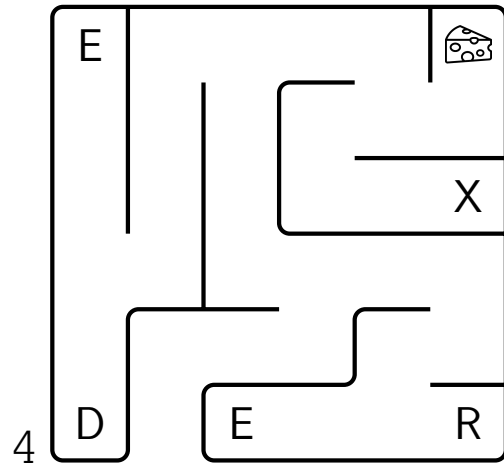
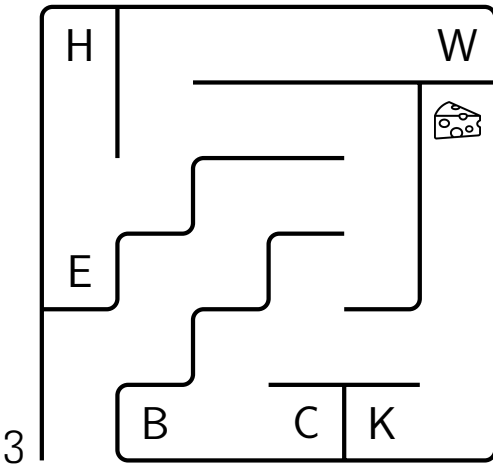
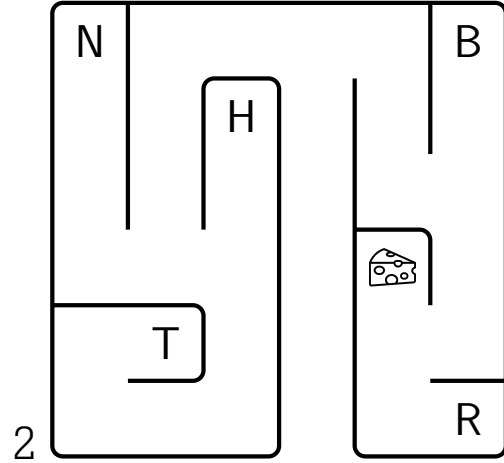
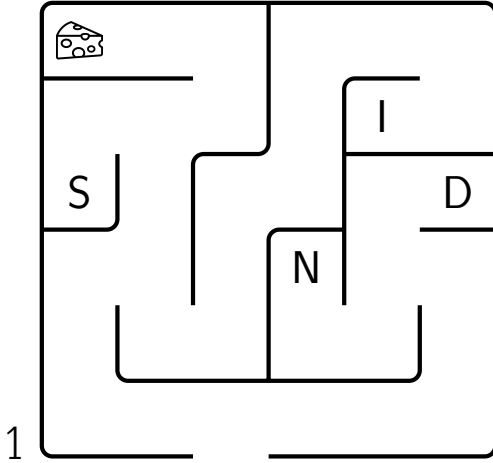

RAT GENETICS

Before the rats escaped, scientists altered their DNA at the base-pair level.
What trait did they give these rats?

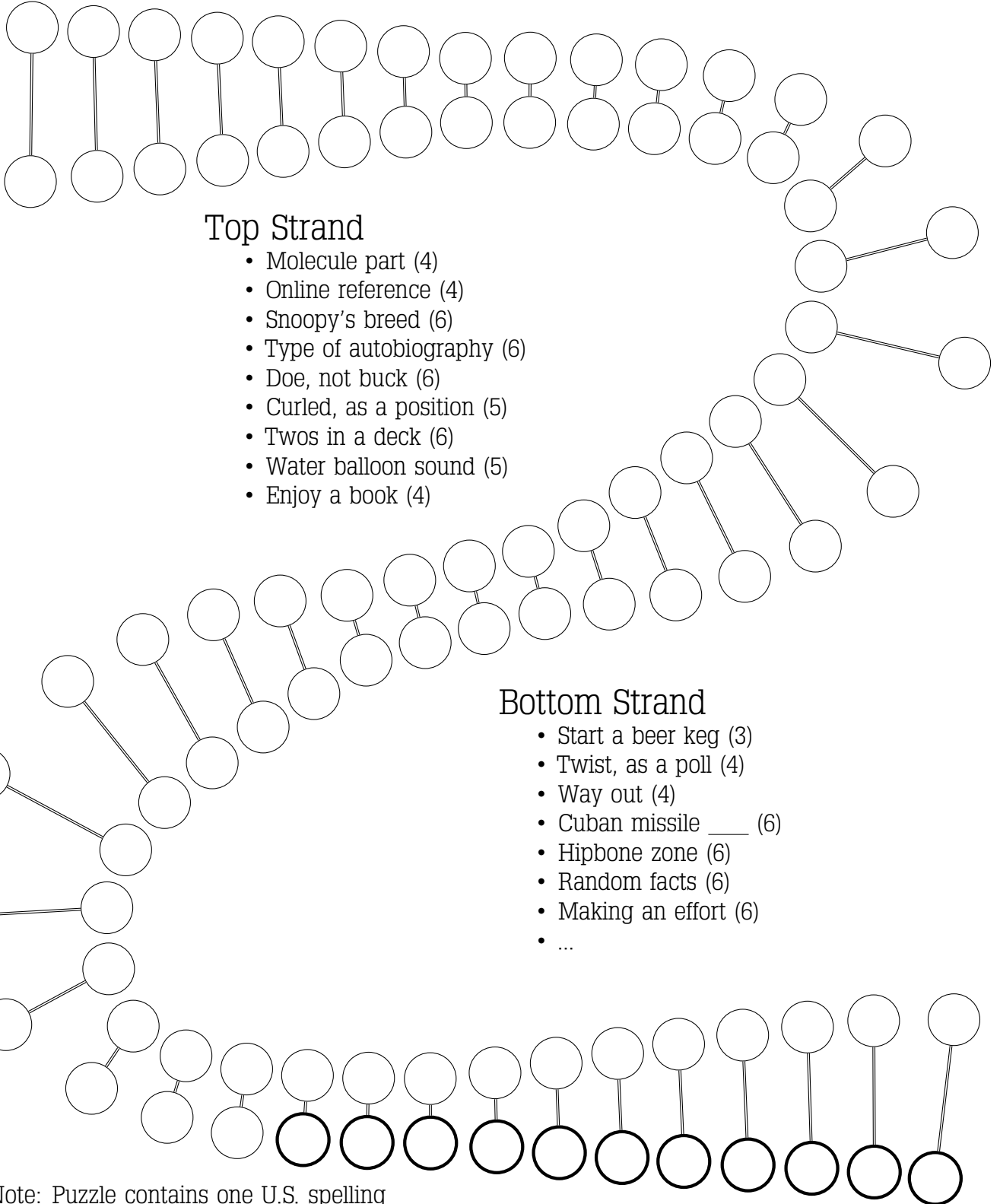

Note: Puzzle contains one U.S. spelling

MISSING RATS

The rats have escaped, and only the scientist's notebook remains. Put a rat back in each cage, then add one more rat to find the tool they used to get out.

TIER	VIBE	CUTE	RED
HER	CASTE	CUE	ERIC
GIN	CHLOE	TAN	BEE
HYDE	ION	PIE	UNIFIED



She loves cheese. Especially when baked with potatoes.

After the injury, he now needs a peg leg and an eyepatch.

This one's cage is more shabby and wretched.

Caught him on video self-stimulating. Don't let the kids watch it.

She has a nervous twitch so fast that it's a blur.

Exudes some chemical that set her sawdust on fire.

Collects and organizes her food pellets in a sort of exhibition on her walls.

Unpredictable.



Very careful with her food. She eats a little, then stashes the rest.

My wicker chair was chewed to pieces. I suspect it was her fault.

He drinks so much water.

He came free with my order of the other 15. I can see why.

Caught her scolding the others today.

Declared himself the leader, but the others have not agreed yet.

Clearly, she has preferences.

He has too much aggression. Needs to be neutered.

RAT KING

Eleven rats are tied together in a rat king, and each one is thinking about how it got stuck. Index their thoughts to learn how a twelfth rat got attached.

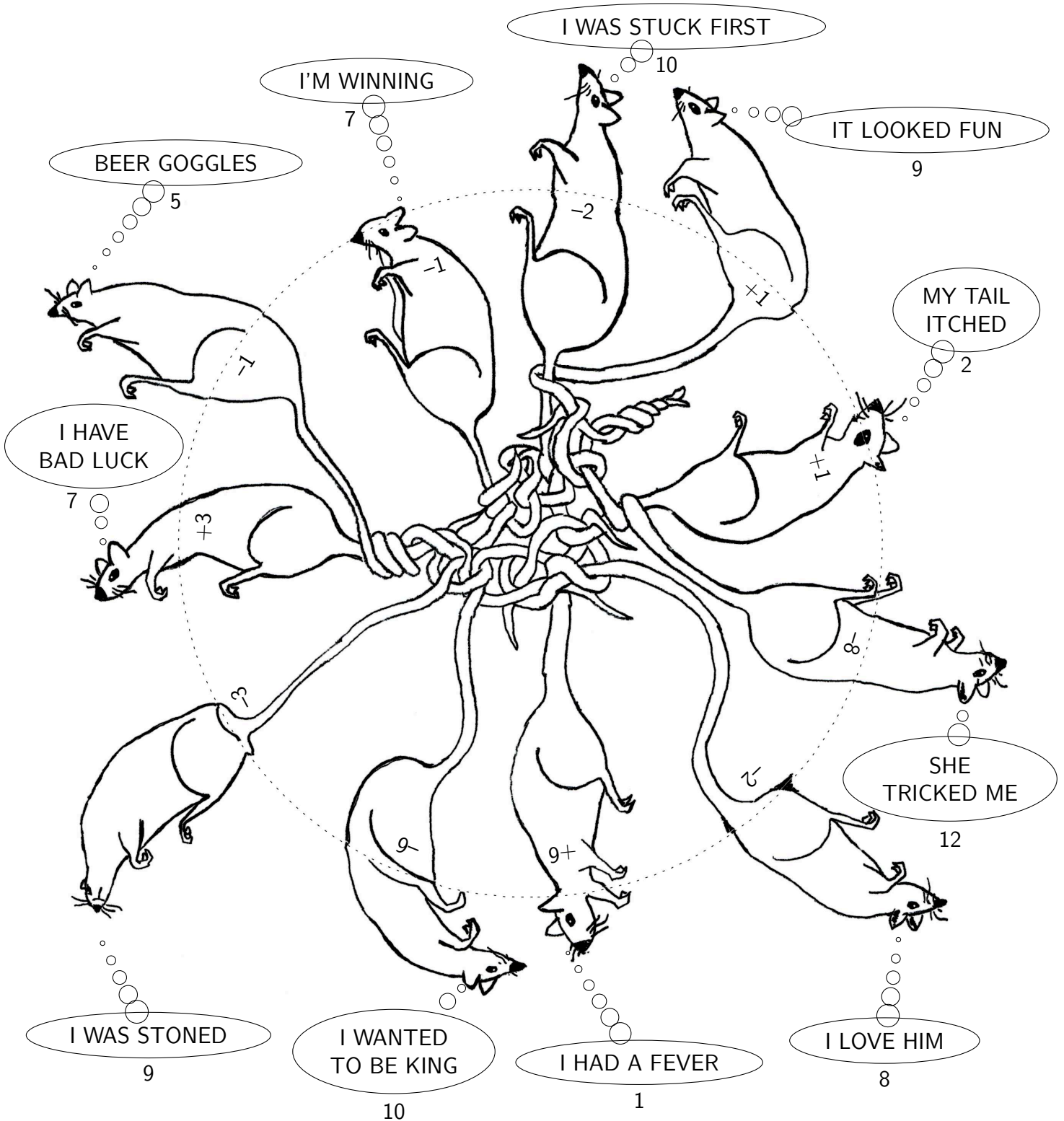



Puzzled Pint



September 2016

SEWER RATS

The rats end up in the sewers beneath the city. They stagger around blindly, blocking the sewers so that toilets overflow in the city bars. How should we get rid of these rats?

